

INSTALLATION MANUAL



INTELLIGENT TOILET

How does ios download the App?

How to download the APP

1. Enter the "App Store" in phone;
2. Search the keyword "smart toilet", then download.
3. Open the APP.
4. Connect the toilet, then you can use.

NOTE: Only the toilet with app function, can work.

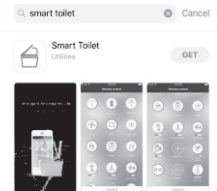

App Store

How does Android download the app?

How to download the APP

1. Enter the "Play Store" in phone;
2. Search the keyword "smart toilet", then download.
3. Open the APP.
4. Connect the toilet, then you can use.

NOTE: Only the toilet with app function, can work.

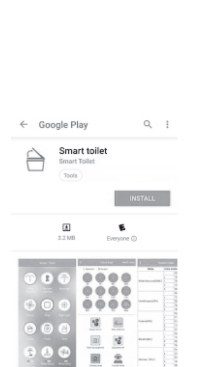

Play Store

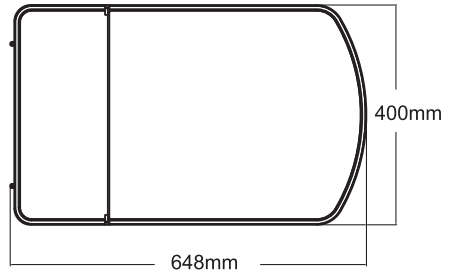
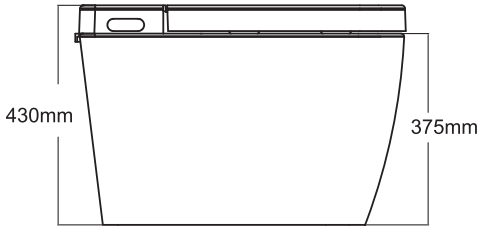

Floor drain S-Trap (Standard services)

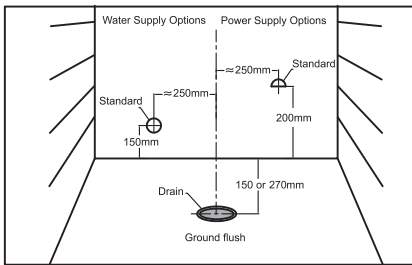

Roughing-in: ST17&ST19:270mm
ST18&ST20:150mm

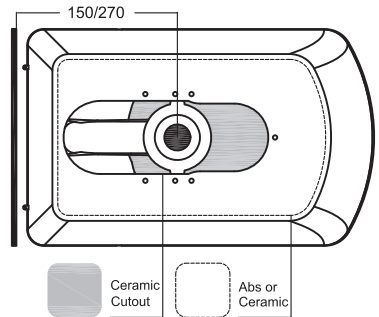





Diameter of Water Outlet	1½" G	Inlet Water Hose Length	60cm	Length of Power Cord	150cm
Water Pressure	Minimum 150kPa. Maximum 750kPa. (dynamic pressure 1.5 - static pressure 7.5kg) If the roughing-in is 270mm, the minimum flow rate is 20 L / min; If the roughing-in is 150mm, the minimum flow rate is 37.5 L / min				
Electrical	Standard 10amp power point required				
Installation	Installation is made by a LICENSED plumber. Mains water only, do not use rain water.				

The position of the power outlet and water outlet can also be flexible according to the real situation.

S-TRAP Installation Manual

1 Cautions for safety. Please observe the following rules.

**The following symbols are used to indicate important safety instructions for the use of the product.

 Danger	Indicates an imminently hazardous situation which, if not avoided, will result in death or serious injury.
 Warning	Indicates dangerous situations where the user could suffer death or serious injury if this product is used incorrectly.
 Do not dismantle	Indicates not to dismantle this product.
 Observe strictly	Indicates to observe the following precaution before using this product.

★ Tip: When you have multiple smart toilets, set them to different channels for remote control.

Setting channel steps:

1. Please plug in the toilet.
2. Press the STOP button on the toilet panel, hold down the button.
3. Meanwhile press REAR SOFT button to change the channel.
4. There are 8 channels for you to choose, you can hear different beep on different channels. Choose one of them.
5. Take out the remote control, hold down the two buttons “+” and “-” until hearing the beep, release the buttons immediately. Channel setting is complete.

★ Note: Press the “CHOOSE” button for 3 seconds to open or close the motion sensor.

Accessories



Flange (option)

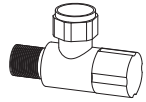

Water shutoff valve

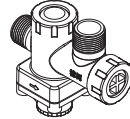

Constant pressure valve

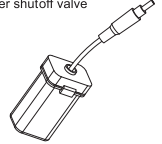

Battery box



Adapter



Remote control

2 Install the Battery box (Batteries not included.)

Put the battery in the battery box, then connect the Battery box to the toilets.

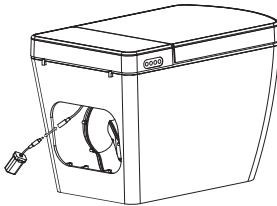

3 Install the Flange on the floor.

1. Fix the flange on the bottom
2. Connect the toilet with flange to the drain pipe on the floor.
3. Slightly press the toilets after the toilet connected to make the connection more better.

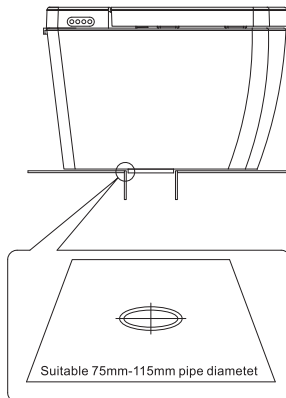
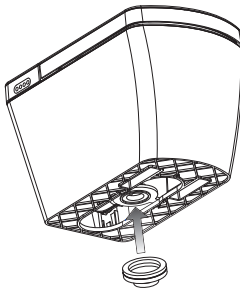

Note: The expansion pipe type toilets do not need flange, just connect the Drain pipe directly.

4 Install shutoff Valve

1. Close the main water supply.
2. Wind Teflon tape around water shutoff valve.
3. Connect the adapter and shutoff Valve, tighten up with wrench.
4. Connect the constant pressure valve.

Note: After installing the shutoff Valve, please turn on the water supply and Valve to flush the dirt for 30s and check whether there is a leakage.

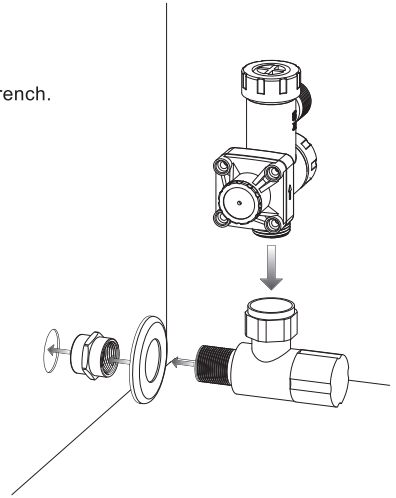

5 Connect the hose

Fix the hose to the Constant pressure valve.

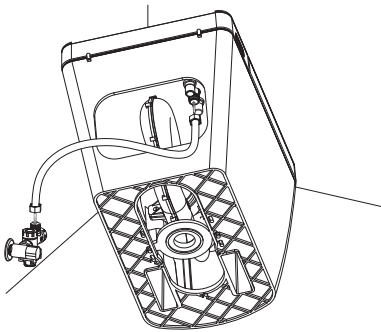

6 Apply Silicone.

1. Flush the toilets and find whether there is a leakage with a paper.
2. Water may get into the part between the lower end of the toilet and the floor and leave stain. Apply Silicone (Not Concrete) to prevent water penetration.

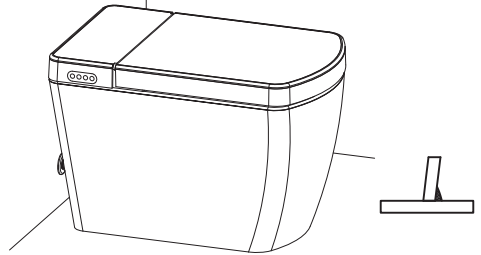

7 Connect Power

1. Insert the power plug into the outlet.
2. Turn on the shutoff valve.
3. Press the flush button on the remote control to do a test.

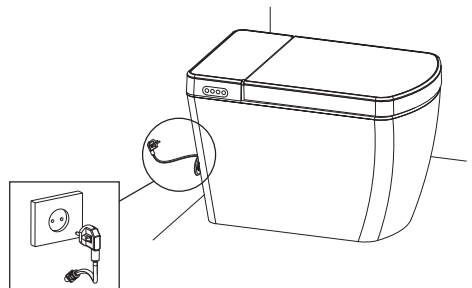
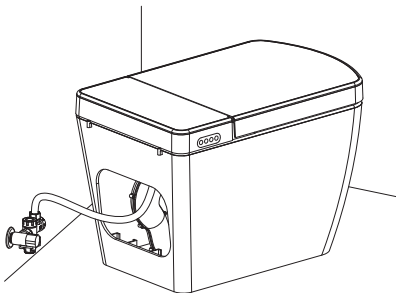

INTELLIGENT TOILET